

Edition: A/1  
Publication Date: August 22, 2022

**ROBAM**

**ROBAM**



User Manual  
**WKQS-26-CQ935H01**  
Compact Oven with Microwave

If the manual is lost, you can send e-mail to [overseas@robam.com](mailto:overseas@robam.com), request for an electronic manual.

# Contents

Safety Precautions ..... 1  
 Product Introduction ..... 4  
 Installation Instruction ..... 7  
 Usage Method ..... 11  
 Maintenance and Service ..... 22  
 Common Faults and Fault Dropping ..... 23  
 Electrical Schematic Diagram ..... 24

## Safety Precautions

This appliance is not intended for use by persons (including children) with reduced physical, sensory or mental capabilities, or lack of experience and knowledge, unless they have been given supervision or instruction concerning use of the appliance by a person responsible for their safety.

Children should be supervised to ensure that they do not play with the appliance

The compact oven with microwave is intended for heating food and beverages. Drying of food or clothing and heating of warming pads, slippers, sponges, damp cloth and similar may lead to risk of injury, ignition or fire

All of the following instructions are important safety instructions. Please strictly observe them and use them correctly after fully understanding them. We will not be liable for any property loss or personal injury whatsoever arising as a result of improper operation of this product.

- ◆ Hold the end of the plug and pull it out when pulling out the plug on the socket. Do not pull out the plug with the power cord, otherwise it is prone to hazards such as electric shock, short circuit and fire.
- ◆ Be sure not to use a power socket that is loose or contacted poorly, otherwise such dangers as electric shock, short circuit and fire may occur.
- ◆ **WARNING:** Ensure that the appliance is switched off before replacing the lamp to avoid the possibility of electric shock.
- ◆ The complete appliance shall be kept far away from heat sources and inflammables (e.g. gas and alcohol). Keep away from damp places, live areas, or sinks.
- ◆ If the appliance door cannot be opened and the door hinge is damaged, do not use the appliance.
- ◆ If the metal screen inside the appliance door is slightly bent or deformed, do not use the appliance.
- ◆ Do not knock panel, internal chamber, appliance door, and other parts to avoid

appliance failure.

- ◆ **WARNING:** If the door or door seals are damaged, the oven must not be operated until it has been repaired by a competent person.
- ◆ Remove all packaging materials of the appliance before installation. If they are not removed, they may cause sparking, burns and other hazards during work.
- ◆ Do not start the microwave mode without placing any food. When there is no food or water absorbing microwave energy in the inner chamber, the microwave energy will be constantly reflected in the inner chamber, which will cause too-high inner temperature and thereby result in abnormality.
- ◆ When using the appliance, please use proper containers for food. When using microwave mode, do not put metal objects in the oven, including metal containers, containers with metallic decorations, knives, forks and other tableware.
- ◆ During use the appliance becomes hot. Care should be taken to avoid touching heating elements inside the oven.
- ◆ The appliance is only suitable for home cooking and cannot be used for other purposes than cooking food, such as drying items, which may cause a fire.
- ◆ The appliance shall not be used for laboratory experiments or other commercial purposes.
- ◆ If smoke is observed, switch off or unplug the appliance and keep the door closed in order to stifle any flames.
- ◆ Do not heat chemical reagents or other non-food products in microwave mode to avoid microwave leakage.
- ◆ If the supply cord is damaged, it must be replaced by the manufacturer, its service agent or similarly qualified persons in order to avoid a hazard.
- ◆ Use a separate 10A or higher socket, and be sure not to connect several appliances to the same power socket at the same time, and make sure that the socket is grounded safely and effectively.
- ◆ If the appliance fails, please power it off immediately and stop using, and do not touch the appliance, and ask a professional to repair it.
- ◆ Do not damage the power cord. When using the power cord, make sure that the cord is not bent, stretched, twisted or knotted. And, be sure not to press or attack the power cord with weight.
- ◆ To prevent fire, appliances must be kept clean and air ducts must be unobstructed.
- ◆ **WARNING:** Do not use harsh abrasive cleaners or sharp metal scrapers to clean the oven door glass, since they can scratch the surface, which may result in shattering of the glass.
- ◆ Never place any flammable substance (e.g. smoke agent) in or under the appliance. When using the appliance, be sure not to spray any smoke agent around it and that the appliance is always supervised.

- ◆ In case the appliance is not to be used for an extended period of time, please cut off the power.
- ◆ Be sure not to operate the appliance when any of your hand or foot is wet or your feet are bare.
- ◆ Turn off the appliance immediately after using, otherwise the residual fat may cause a fire.
- ◆ Before cleaning, be sure to turn off the power first and use a neutral cleaner. Moreover, make sure to clean it with a soft piece of cloth, in order to prevent its surface from being scratched.
- ◆ When in microwave mode, The contents of feeding bottles and baby food jars shall be stirred or shaken and the temperature checked before consumption, in order to avoid burns.
- ◆ After use, do not clean the appliance directly. Be sure to clean it after cooling to avoid scalding.
- ◆ When in microwave mode, Only use utensils that are suitable for use in microwave ovens and cannot be cooked directly on the bottom glass.
- ◆ Non-professionals are not allowed to install, disassemble, repair or replace the machine or replace any of its parts without permission.
- ◆ **WARNING:** It is hazardous for anyone other than a competent person to carry out any service or repair operation that involves the removal of a cover which gives protection against exposure to microwave energy.
- ◆ When making popcorn in microwave mode, a special popcorn container must be used. Some food packaged in paper bags can be cooked directly. People shall not leave when cooking.
- ◆ When heat potatoes, apples, sausage, chicken wings and other food with skin in microwave mode, food must be perforated with a knife and fork to prevent rupture or explosion.
- ◆ When in microwave mode, Eggs in their shell and whole hard-boiled eggs should not be heated in microwave ovens since they may explode, even after microwave heating has ended.
- ◆ Microwave heating of beverages can result in delayed eruptive boiling, therefore care must be taken when handling the container.
- ◆ When heating food in plastic or paper containers, keep an eye on the oven due to the possibility of ignition.
- ◆ **WARNING:** Liquids and other foods must not be heated in sealed containers since they are liable to explode.
- ◆ Do not overcook food in microwave mode.
- ◆ **Warning:** Do not let unattended children and the disabled use the product or let children play with it.
- ◆ **WARNING:** Accessible parts may become hot during use. Young children should be kept away.

- ◆ Do not allow children and others unfamiliar with the appliance to operate the product.
- ◆ When the appliance works in the combination mode, children must use it under the supervision of adults due to the temperature rise.
- ◆ Failure to maintain the oven in a clean condition could lead to deterioration of the surface that could adversely affect the life of the appliance and possibly result in a hazardous situation.
- ◆ If the appliance functions abnormally, please disconnect the power plug and power it on again.
- ◆ The internal crisp plate should be placed properly during use.
- ◆ The appliance cannot be used as an indoor heater.
- ◆ Do not clean this product with a steam cleaner.
- ◆ **WARNING:** Do not put the crisp plate on the bottom glass in microwave mode.

## Product Introduction

### Dear Users

Thank you for choosing Robam compact oven with microwave . We recommend that you read this manual carefully before installing and using this product and keep it for future reference.

The company is a professional enterprise producing extractor hood, compact oven with microwave , gas stove, disinfection cabinet, electric oven and other household appliances and kitchenware in China. Robam compact oven with microwave adopts advanced design concept, focusing on overall design and model optimization. It has the advantages of health, environmental protection and energy saving.

Code anti-fake labels are used to ensure that users buy genuine products and safeguard their own interests.

This product belongs to the Class I appliance and must be reliably grounded when used.

※ All pictures of the product in the Manual are for reference only. The real products shall prevail. Our products are constantly improved. The manual will be subject to change without prior notice.

**Important Information**

**Packaging of Compact Oven with Microwave**

Please dispose of these packaging materials in an environmentally friendly way to maintain a good environment.

Do not allow children to play with packaging materials such as plastic films and paper boxes, as this may cause suffocation accidents. Therefore, please keep the packaging materials away from children.

**Product Structure**

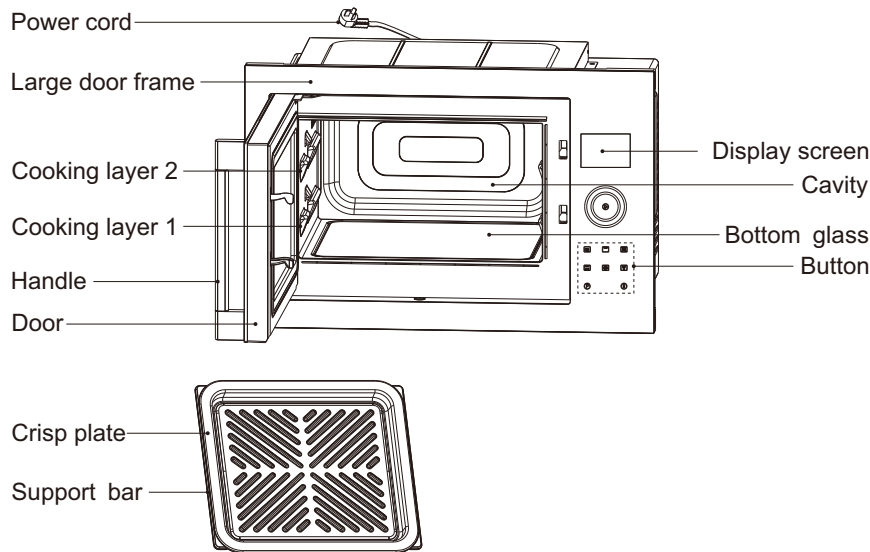

**Technical Parameters**

Model	WKQS-26-CQ935H01
Rated Voltage	220-240V ~
Rated Frequency	50-60Hz
Rated Power Input	1560W
Rated Power Input(Grill)	870W
Microwave Power Output	1000W
Rated Microwave Frequency	2450MHz
Gross Capacity	28L

Effective Capacity	26L
Noise	65dB(A) sound power level
Net weight	17kg
Dimensions (mm) width × height × depth	595 × 385 × 388





**List of Attachments**

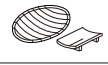

S/N	Description	Qty.
1	Specification	1
2	Crisp plate	1
3	Installation instruction	1
4	Locating plate	1
5	ST4.2 × 12 self-tapping screw	3
6	ST3.5 × 30 self-tapping screw	1

**Selection of Cooking Utensils**

It is necessary to choose appropriate cooking containers for different cooking methods. Please refer to the following table for use.

Container type	Microwave mode	Baking mode	Combination mode
Heat-resistant glass vessels	Usable	Usable	Usable
Non-heat-resistant glass vessels	Unusable	Unusable	Unusable
Heat-resistant plastic vessels	Usable Note: *appliances marked "for microwave oven" shall be used. *Sealed containers are prohibited.	Unusable	Unusable
Non-heat-resistant plastic vessels	Unusable	Unusable	Unusable
Ceramic container	Usable Note: those with metal decorations are prohibited.	Usable	Usable Note: those with metal decorations are prohibited.

Container type	Microwave mode	Baking mode	Combination mode
Metal vessel 	Unusable	Usable	Unusable
Wooden, bamboo and cloth containers 	Unusable	Unusable	Unusable
Aluminium-foil paper, tin-foil paper, etc. 	Unusable	Usable	Unusable
Food fresh-keeping film 	Usable	Unusable	Unusable
crisp plate 	Unsuitable	Usable	Usable

Note: ● It is recommended to use a glass or ceramic container with a wide mouth for microwave ovens in microwave mode. For example,  the use of necked containers is prohibited. For instance: 

- Do not drag the crisp plate on the door when taking and placing it, to avoid damage to the glass.
- Place the crisp plate on the cooking layer.
- The crisp plate, the inner wall and top of the whole oven chamber are very hot after use. Do not touch them with hands to avoid scalding.
- Clean crisp plate frequently.
- When cooking food, place the food in the wavy area in the middle of the crisp plate. This is to avoid that the food cannot be fully roasted because it enters the surrounding grooves.
- The crisp plate can be used in baking, combination and double-drive baking and cooking modes.

## Installation Instruction

In the setting position of the cabinet, set the square hole according to the installation diagram below, and embed the compact oven with microwave into the square hole smoothly. Note that tilt placement is not allowed. The specific hole size (mm) is shown in the following table:

S/N	Description	W	H	D
1	Dimension of completely-nested opening (WxHxD)	600	395	450
2	Dimension of half-nested opening (WxHxD)	560	380	450

Installation method:

A. Lay the installation instructions on the bottom of the cabinet, with the center of the instructions aligned with the center of the cabinet. The front edge of the installation instructions shall be aligned with the front edge of the cabinet. Mark cabinets according to the position of screws in the installation instructions. Place the locating plate at the mark in the correct direction and fix it on the cabinet with three screws (4.2×12), as shown in Fig. 4. (the protruding edge of the locating plate faces the front of the cabinet)

B. Put the machine into the cabinet so that the outer frame is about the same distance from the left and right of the cabinet. Push the machine back into place so that the locating plate is stuck in the product locating slot. Open the machine door and fix the product on the cabinet with screws (3.5×30) at the screw position on the front upper part of the liner.

C. When the cabinet is fully embedded, a fixed board shall be installed on the top of the cabinet as shown in Fig. 3.

D. The socket shall be conveniently plugged and reliably grounded.

Note: all dimensions in the drawing are in mm.

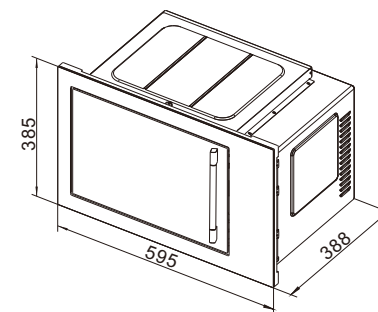
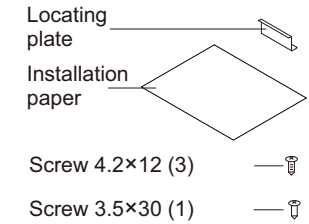

Fig. 1: schematic diagram of overall dimensions

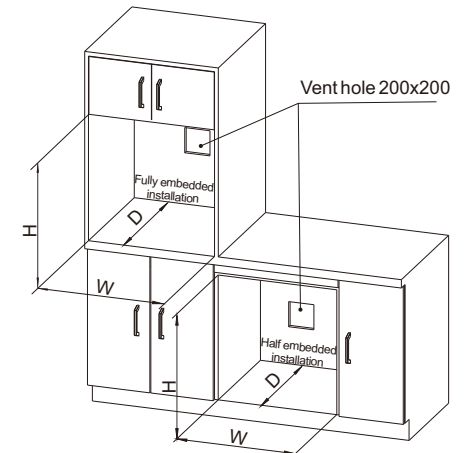
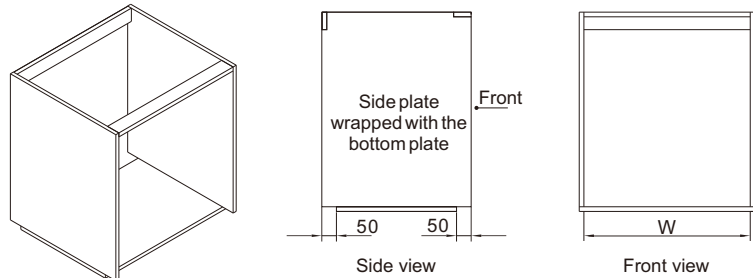

Fig. 2: schematic diagram of opening dimensions



Note: If the product is installed in a floor cabinet, the floor cabinet structure diagram shown in the above figure is recommended to ensure the consistent visual effect between the product door body and left & right cabinet doors.

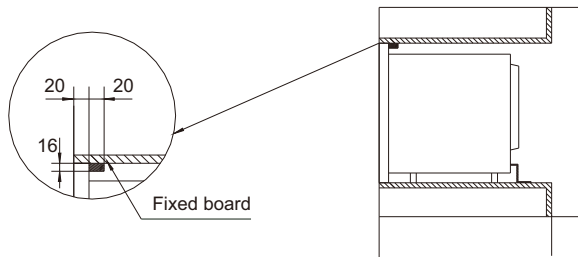

Fig. 3: schematic diagram of fully embedded installation of fixed board

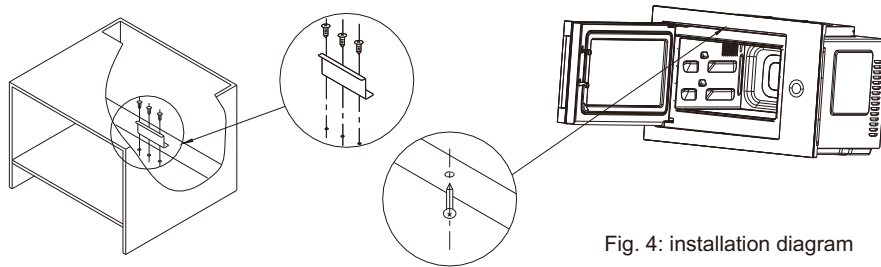
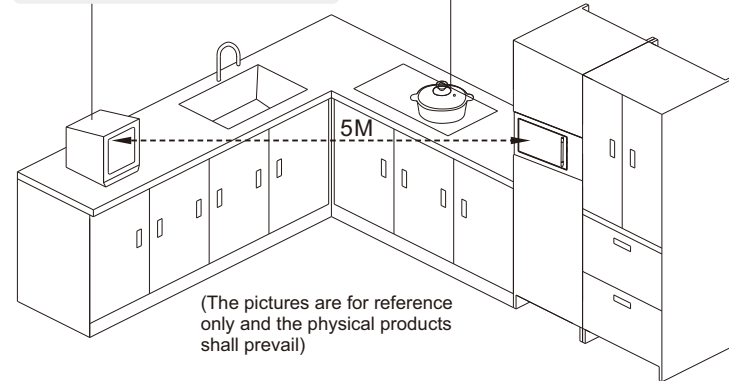

Fig. 4: installation diagram

Be sure the oven is far away from such appliances as TV set, radio and antenna. (Otherwise, interference to the image or sound of these appliances will occur)

Do not place the compact oven with microwave in a place with high temperature and humidity. For example, near a gas stove, live areas or sinks.



(The pictures are for reference only and the physical products shall prevail)

Note: the upper part of the top shell of the complete appliance shall maintain a gap of more than 3mm with the cabinet.

**Power supply:** the Robam compact oven with microwave shall adopt a separate power supply system. If this system is not used, the fuse may blow or the cooking time may be prolonged. However, high-capacity fuses are not supposed to apply in the power system.

**Grounding instructions:** the equipment must be grounded. The plug must be plugged into a properly grounded socket. The power cord must be easily connected and disconnected to ensure that the power supply can be disconnected at any time after the oven is installed.

Note: if the indoor temperature is too high, the compact oven with microwave cannot be used. The compact oven with microwave is for residential use only.

## Usage Method

### Introduction to control panel

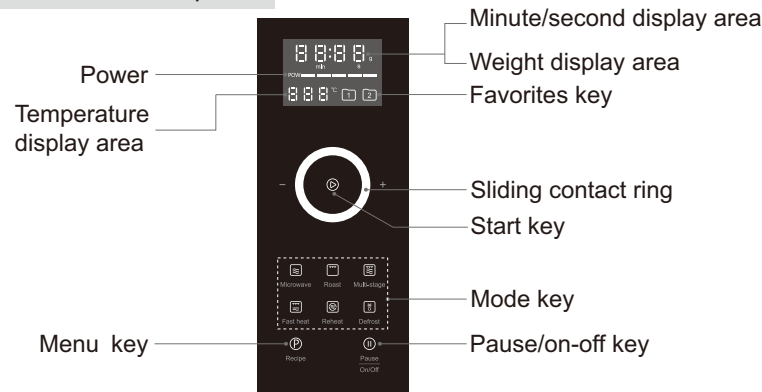

### Instructions before Use

- When the new product is used for the first time, the volatilization of the protective coating of the heating element will produce a peculiar smell. Under the condition of ensuring good ventilation around the product, select the roast mode, set 180°C and run the cavity for 60 minutes to remove the protective coating. After the work is finished and the machine is cooled, wipe and clean the inner tank with a wet rag. Subsequent cooking can be carried out normally, and the product will no longer produce odor.

### How to Use

#### 1. Power on

Turn on the power, sound a beep, the screen display and key full light, the circle breathing flashing, a few seconds later the screen display " - - ", the key off, the circle off, sound a beep into the standby state (the following figure), standby state press any key or touch screen area to enter the wait for the power on state, pause/on key flashing (the following figure).



Note: when waiting for a startup, the machine will return to the standby state if there is no operation within a few minutes.

#### 2. Startup

Long press the “⏸” key to start up and enter the default mode (as shown in the figure below).



#### 3. Select cooking mode

Users can choose from six cooking modes according to their own needs, including microwave “☰” roast “☱” multi-stage “☲” fast heat “☴” reheat “☵” and defrost “☶”.

#### Microwave and Multi-stage Mode

- ① In the mode selection state, press the mode key to select the required mode;
- ② To adjust the cooking firepower, press the firepower bar. Then, the firepower bar flashes. The firepower can be adjusted by continuously pressing the firepower bar and the flashing mode key, and the firepower can be

- increased/decreased by pressing the sliding contact ring;
- To adjust the cooking time, press the minute display area. Then, the minute display area flashes. To adjust the minutes, short press the sliding contact ring. Press the second display area. Then, the second display area flashes. To adjust the seconds, press the sliding contact ring;
  - After setting, press the "▶" key to start and enter the working mode automatically. When the work is finished, the buzzer will beep.



Roast Mode

- In the mode selection state, press the roast key to select the roast mode.
- To adjust the cooking temperature (the temperature is divided into three gears: 140°C, 160°C and 180°C), press the temperature display area. Then, the temperature display area flashes. The temperature can be adjusted by continuously clicking the temperature display area and the flashing braking key, or by pressing the sliding contact ring.
- To adjust the cooking time, press the minute display area. Then, the minute display area flashes. To adjust the minutes, press the sliding contact ring. Press the second display area. Then, the second display area flashes. To adjust the seconds, press the sliding contact ring.
- After setting, press the "▶" key to start and enter the preheating state. After preheating, the buzzer will beep and automatically enter the working mode. When the work is finished, the buzzer will beep.

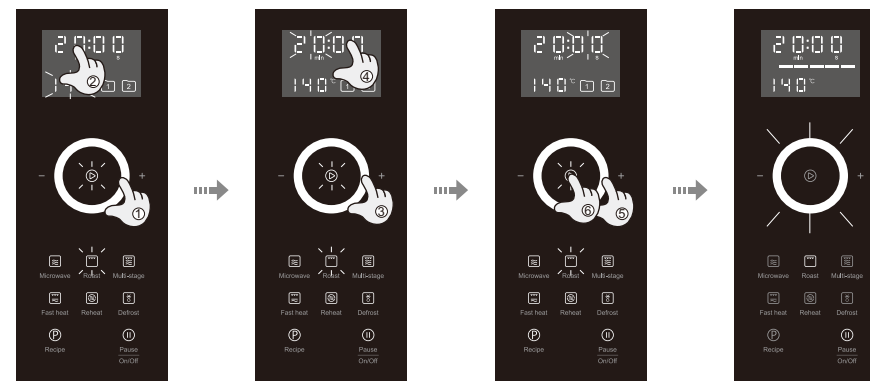

Fast heat Mode

- In the mode selection state, press the fast heat key to select the fast heat mode.
- To adjust the cooking time, press the minute display area. Then, the minute display area flashes. To adjust the minutes, press the sliding contact ring. Press the second display area. Then, the second display area flashes. To adjust the seconds, press the sliding contact ring.
- The cooking firepower is divided into 5 gears by default and cannot be adjusted.
- After setting, press the "▶" key to start and enter the working mode automatically. When the work is finished, the buzzer will beep.

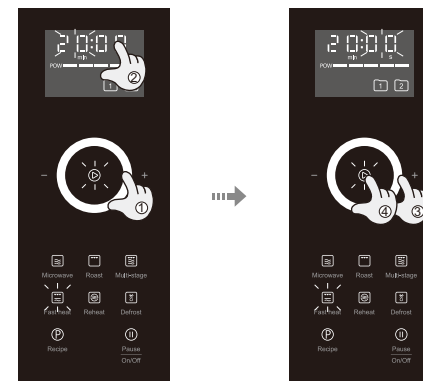



**Reheat and Defrost Modes**

- ① In the mode selection state, press the mode key to select the required mode.
- ② If the weight needs to be adjusted, press the sliding contact ring. Press once to adjust 100g (the weight adjustment range in reheating mode is 200g-600g, and the weight adjustment range in defrosting mode is 100g-3,000g).
- ③ The cooking firepower in reheat mode is divided into 5 gears by default and 2 gears in defrost mode, and it cannot be adjusted.
- ④ After setting, press the "▶" key to start and enter the working mode automatically. When the work is finished, the buzzer will beep.



- Note:** ● If there is no need to adjust the cooking firepower, time, temperature and weight, press the "▶" key directly after selecting the mode to start.
- When setting the firepower, time, temperature and weight, users can adjust according to the cooking reference list or personal taste and cooking experience.
  - Long press both ends of the sliding contact ring or slide the ring to continuously increase/decrease the parameters.
  - Cooking memory function is available in some modes. If the power is not off, the cooking mode of the last operation can be continued when the power is turned on again.

**Menu function**

1. Press the "Ⓟ" key to enter the menu setting state, the screen displays the time parameters and units, and the menu S/N, menu key and start key flash.
2. Press the menu S/N or sliding contact ring to select the required menu, and its corresponding relationship is shown in the table below:
3. After selection, press the "▶" key to enter the working state.

- Note:** ● To adjust the time parameter, press the minute/second display area. Then, the minute/second display area flashes. Press the sliding contact ring to adjust the time. After the adjustment is completed, press the "▶" key to enter the working state.
- Press "Ⓟ" key again to exit the menu function.

**Menu S/N corresponding table**

S/N	Menu name	Cooking layer position	Preheating required or not
P01	Coarse grain rice	Bottom glass	/
P02	Minced meat congee with preserved egg	Bottom glass	/
P03	Bread with a crispy base	1	/
P04	Baked fish with Sichuan flavor	2	/
P05	Bacon and vegetable roll	2	Yes
P06	Assorted kebabs	2	/
P07	Roasted beef	1	/
P08	Baked pizza	2	/
P09	Egg sandwich	1	/
P10	Popcorn	Bottom glass	/
P11	Orleans chicken wing	2	/
P12	Crispy and tender chicken chops	2	Yes
P13	Roasted oysters	2	Yes
P14	Grilled lamb chop with Rosemary	2	/
P15	Shrimps with bean curd	Bottom glass	/
P16	Garlic prawns	Bottom glass	/

- Note:** ● Some recipes require food to be taken out for processing, and the machine will beep to remind users.

**■ Favorites settings**

1.Common modes and parameters can be added to favorites for future use. Specific operations are as follows: If the "microwave" function is added to favorites, set the firepower and time parameters of the microwave function in the startup state and long press the " 1 " or " 2 " key. The buzzer will beep to remind that the favorites setting is completed.

2.To use the parameters in the favorites, press " 1 " or " 2 " key and then directly press " ▶ " key to start cooking. To exit favorites, first press " ⏸ " key to pause work, and then press " 1 " or " 2 " key to exit.

Note: ● Only microwave, baking, combination and double-drive baking modes can be added to favorites.  
 ● The existing favorites parameters cannot be adjusted.  
 ● The current favorites can overwrite the existing favorites parameters.

**■ Adjustment settings**

To change the set mode, firepower, time, temperature and weight during operation, please press the " ⏸ " key to stop operation and enter the adjustment state. Then, reset the mode, firepower, time, temperature and weight. After adjustment, press the " ▶ " key to start work.

Note: ● The weight cannot be adjusted after the reheating and defrosting modes are suspended.

**■ Lighting function**

1.The light is always on in the working state. When the work is suspended or finished, the light will be turned on automatically, and the light will be off without any operation after a few minutes.  
 2.The light will be turned on automatically when opening or closing the door, and the light will be off without any operation after a few minutes.





**■ Shutdown**

1.Long press the " ⏸ " key in the startup state to enter the standby state.  
 2.In the off-working state, it will automatically enter the standby state without any operation after a few minutes.  
 3.It will enter the standby state after the work is finished.





**Working Mode**





Function	Default firepower	Default temperature	Default weight	Default time
Microwave	POW ██████████	/	/	30s
Roast	/	Gear 3: 180°C	/	20min
Multi-stage	POW ██████████	/	/	20min
Fast heat	POW ██████████	/	/	20min
Reheat	POW ██████████	/	200g	/
Defrost	POW ██████	/	100g	/

Function	Firepower range	Temperature range	Weight range	Time range
Microwave	POW ██████████	/	/	5s-90min
	POW ██████████			
	POW ██████████			
	POW ██████████			5s-30min
	POW ██████████			
Roast	/	Gear 1: 140°C	/	1-90min
		Gear 2: 160°C		
		Gear 3: 180°C		
Multi-stage	POW ██████████	/	/	1-90min
	POW ██████████			
	POW ██████████			
	POW ██████████			
	POW ██████████			
Fast heat	POW ██████████	/	/	1-90min

Function	Firepower range	Temperature range	Weight range	Time range
 Reheat		/	200g-600g	/
 Defrost		/	100g-3000g	/

### Cooking Reference List

Mode	Food	Cooking layer position	Appliances used	Temperature (°C)/gear	Setting time (min)
 Microwave	Jumbo shrimp	Bottom glass	/	Gear 5	4-10
	Vegetables (spinach)	Bottom glass	/	Gear 4	4-10
	Tofu	Bottom glass	/	Gear 5	5-10
	Sandwiches	1	/	Gear 3	2-10
	Popcorn	Bottom glass	/	Gear 5	2-6
 Roast	Bacon and vegetable roll	2	Crisp plate	180	8-25
	Oysters	2	Crisp plate	180	5-25
	Chicken chop	2	Crisp plate	180	10-30
	Sliced bread	1	Crisp plate	180	5-15
	Cake roll	1	Crisp plate	140	20-35
	Cranberry cookie	1	Crisp plate	160	10-25
 Fast heat	Bread with a crispy base	1	Crisp plate	/	10-25
	Pizza	2	Crisp plate	/	15-30
 Multi-stage	Grilled fish	2	Crisp plate	Gear 5	15-40
	Kebab	2	Crisp plate	Gear 5	18-30
	Steak	1	Crisp plate	Gear 4	5-20
	Lamb chop	2	Crisp plate	Gear 5	15-35
	Chicken wing	1	Crisp plate	Gear 5	15-30
	Drumsticks	2	Crisp plate	Gear 5	15-40

Mode	Food	Remarks
 Microwave	Jumbo shrimp	About 300g frozen prawn
	Vegetables (spinach)	About 400g spinach cut into two pieces
	Tofu	About 300g lactone tofu sliced
	Sandwiches	4 slices of toast
	Popcorn	About 100g microwave popcorn
 Roast	Bacon and vegetable roll	About 250g bacon and about 200g vegetables
	Oysters	About 800g oysters
	Chicken chop	About 150g chicken breast
	Sliced bread	9 pieces of toast with edge removed
	Cake roll	1 crisp plate, 6 eggs
	Cranberry cookie	1 crisp plate
 Fast heat	Bread with a crispy base	About 50g/piece, 8 in total
	Pizza	8-inch quick-frozen pizza base
 Multi-stage	Grilled fish	About 450g bass
	Kebab	About 60g/string, 9 in total
	Steak	About 200g steak, 1 in total
	Lamb chop	About 600g French lamb chop, 6 in total
	Chicken wing	Chicken middle wings, 12 in total
	Drumsticks	Drumsticks, 2 in total

#### Note:

- The food cooking temperature and time in the above table are only for reference. During the cooking process, users can adjust the cooking temperature, time, mode and cooking layer according to their personal taste and cooking experience.
- In baking mode, it is recommended to roast chicken, duck and larger meat at low temperature first and then switch to high temperature for better taste.
- In the baking mode, the user can marinate the food with the prepared ingredients for about 30-40 minutes before baking, which will enhance the flavor of the food.
- Users can also choose different cooking modes for the same food according to their personal cooking experience.
- In the baking mode, it is recommended that the food be turned over to ensure that it is evenly heated.
- In the actual cooking process, the cooking time should be adjusted appropriately due to the influence of the appliance and food weight.
- In defrost mode, the defrosting effect is different due to the size, shape and type of ingredients. The defrosting weight data is for reference only, and users can adjust the weight data to increase/decrease the defrosting time according to the actual situation.

**Common Phenomena and Treatment Methods during Baking**

Phenomena	Cause analysis	Handling
Uneven baking	<ul style="list-style-type: none"> <li>*The baking layer is incorrect</li> <li>*The food is not placed in the middle of the crisp plate</li> <li>*The function is selected incorrectly</li> </ul>	<ul style="list-style-type: none"> <li>*Select the right baking layer</li> <li>*Place the food in the middle of the crisp plate</li> <li>*Select the correct function</li> </ul>
The top or bottom of the baked food is darker	<ul style="list-style-type: none"> <li>*The function is selected incorrectly</li> <li>*The food is of different sizes or the food is not evenly placed</li> <li>*The baking temperature is too high</li> <li>*The baking layer is too high or too low</li> <li>*The door of compact oven with microwave is opened too many times during baking</li> </ul>	<ul style="list-style-type: none"> <li>*Select the correct function</li> <li>*Cut the food evenly in size and place it evenly on the baking tray</li> <li>*Turn down the temperature</li> <li>*Put the food to a lower or higher layer</li> <li>*Open the door at least halfway baking time</li> </ul>
The baked cake has cracks and deep crust.	<ul style="list-style-type: none"> <li>*The time is too long</li> <li>*The baking temperature is too high</li> <li>*The baking layer is too high</li> <li>*The recipe or operation process of making cake is wrong</li> <li>*The vessel is not suitable</li> </ul>	<ul style="list-style-type: none"> <li>*Adjust time</li> <li>*Turn down the temperature</li> <li>*Lower one layer</li> <li>*Adjust the formula and operate the process correctly</li> <li>*Replace with a suitable vessel</li> </ul>
The baked food is light in color and not thoroughly baked	<ul style="list-style-type: none"> <li>*The baking temperature is too low</li> <li>*The baking layer is too low</li> <li>*The baking time is too short</li> </ul>	<ul style="list-style-type: none"> <li>*Raise the temperature</li> <li>*Raise one layer</li> <li>*Prolong the baking time</li> </ul>

**Maintenance and Service**

**Important note: power off the compact oven with microwave before cleaning it .**

The appliance must be kept clean at all times to ensure that the heating elements and internal cavities are free from fat and oil stains. Crisp plate and other items must be cleaned to avoid fire caused by fat accumulation. For convenience of cleaning, meat can be wrapped in aluminum-foil paper for baking. Any fat or oil stains will form a lacquer layer in the appliance, which is difficult to clean, so they should be cleaned after each use.

1. Inner cavity: clean with warm water. Do not use corrosive and abrasive cleaners. The stains that are difficult to remove can be cleaned with nylon brush or neutral detergent, not with steel ball, to avoid irreparable damage to the surface. The cleaner in the cavity must be cleaned without residue, and then dried with a cloth to keep the cavity dry.

2. Door frame glass and bottom plate glass: the glass surface on the door, control board and baseboard shall be cleaned immediately if it becomes dirty. The firm dirt can be cleaned with neutral detergent, not with steel ball, to avoid scratching the surface. After cleaning, wipe it dry with a rag.

3. Door sealing: it cannot be disassembled. Wipe it with a rag after use. Do not clean it with corrosive and abrasive detergent. The stains that are difficult to remove can be cleaned with nylon brush or neutral detergent, not with steel ball, to avoid irreparable damage to the surface.

4. If the compact oven with microwave operates normally or the humidity is high, water vapor may be generated around the oven door or in the oven, which can be wiped with a soft cloth.

5. Use a piece of soft dry cloth to wipe the control panel (if wet). Do not wipe the control panel with rough and abrasive materials.

6. Please clean the surface of the compact oven with microwave with a soft wet cloth. To prevent damage to the internal parts of the oven, do not let water penetrate into the vent.

## Common Faults and Fault Dropping

The following table lists common faults. Please confirm and rectify the faults according to the instructions listed in the table. If the fault persists or you cannot confirm the cause of the fault, please contact the local dealer or after-sales service center. For your safety, we remind you not to disassemble and repair by yourself.

Fault phenomenon	Causes	Handling method
E3 displayed on the screen	Heating failure The temperature change is less than 5°C within 8 minutes after the operation and does not reach 80% of the set temperature	The fault can be eliminated automatically after entering the standby state. If it fails again, it is recommended to check whether the connector is loose or the heating pipe is abnormal after power off. Restart after troubleshooting. If the fault cannot be eliminated, please contact professional personnel for maintenance.
E5 displayed on the screen	Temperature sensor fault Short circuit or open circuit	It is recommended to check whether the connector is loose or whether the temperature sensor is damaged after power off. Restart after troubleshooting. If the fault cannot be eliminated, please contact professional personnel for maintenance.
E6 displayed on the screen	Communication is faulty Abnormal communication between panel and power board	It is recommended to check whether the communication line or program matches after power off. Restart after troubleshooting. If the fault cannot be eliminated, please contact professional personnel for maintenance.
ERR displayed on the screen	Frequency converter fault Abnormal microwave inoperation or abnormal operation	It is recommended to check whether the connector is loose or whether the frequency converter is abnormal. Restart after troubleshooting. If the fault cannot be eliminated, please contact professional personnel for maintenance.

## Electrical Schematic Diagram

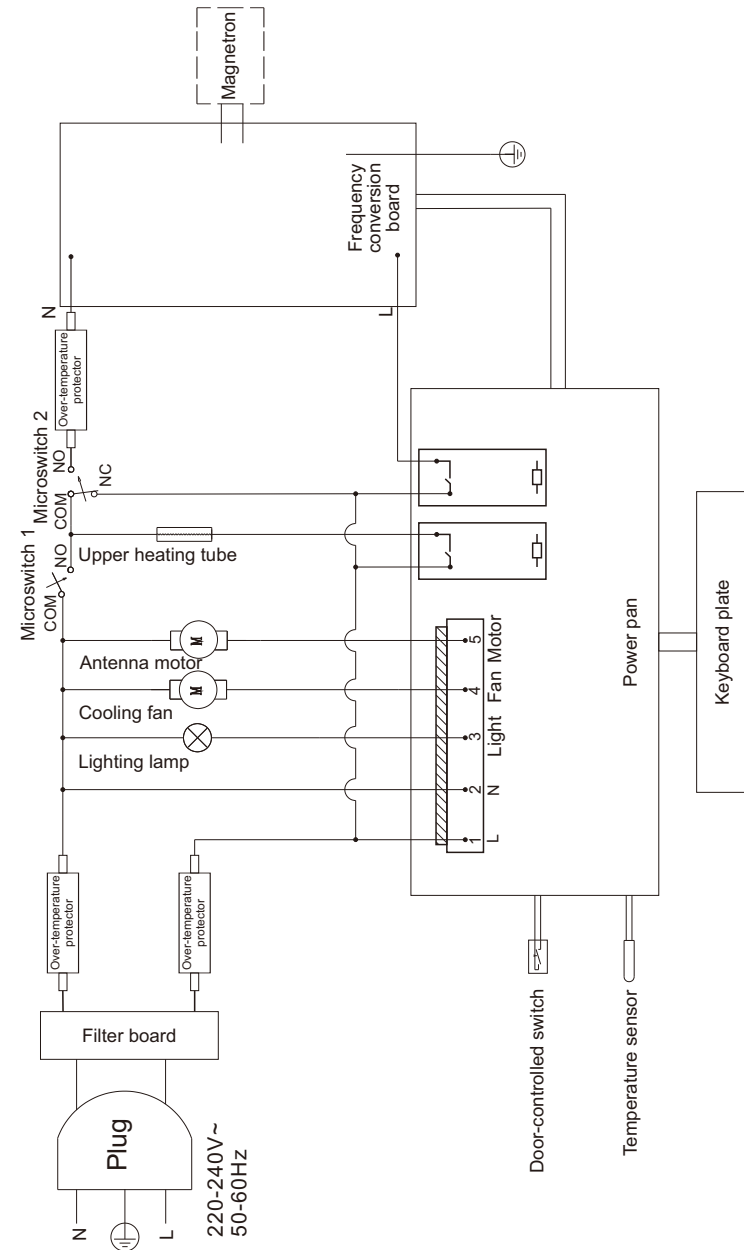

## 目 录

安全注意事项 .....	1
产品简介 .....	3
安装说明 .....	6
使用方法 .....	9
维护和保养 .....	18
常见故障及处理方法 .....	19
电气原理图 .....	20

## 安全注意事项

本设备不适用于身体、感官或精神能力下降或缺乏经验和知识的人（包括儿童），除非负责其安全的人员对他们使用本设备进行了监督或指导。

应监督儿童，以确保他们不玩器具。

带微波炉的紧凑型烤箱用于加热食物和饮料。烘干食物或衣物及加热保暖垫、拖鞋、海绵、湿布及类似物品可能导致受伤、着火或起火的危险。

以下均为有关安全的重要事项，敬请严格遵守，并在充分理解内容的基础上正确使用，由于本产品使用不当造成的任何财产损失、人身伤害，本公司不承担责任。

- ◆ 拔出插座上的插头时，必须手握插头的端部将其拔出，请不要手拿电源线拔插头，否则易发生触电、短路、起火等危险。
- ◆ 请不要使用松动或接触不良的电源插座，否则易导致触电、短路、起火等危险。
- ◆ 警告：为避免可能出现的电击，换灯前应确定器具已断开电源。
- ◆ 整机远离热源，煤气和酒精等易燃物品。远离潮湿的地方，带电区域或水槽旁边。
- ◆ 如果器具门不能打开，门铰链损坏，请勿使用器具。
- ◆ 如果器具门内侧金属网板发生轻微弯曲或变形，请勿使用器具。
- ◆ 不可敲击面板、内腔、器具门等部件，以免导致器具故障。
- ◆ 警告：如果器具门或门封已损坏，则不得再使用，直到专业维修人员修好为止。

- ◆ 安装前取下器具所有包装材料，如不取下，工作过程中有可能导致打火、烧伤等危害。
- ◆ 切勿在没有放食物情况下启动微波模式，没有食物或者水份在内腔内吸收微波能量时，微波能量会在内腔内不停的反射，会引起炉内温度过高而发生异常。
- ◆ 在使用器具时，请使用合适的容器盛放食物。使用微波模式时不能放入金属物体，包括金属容器，具有金属装饰品的容器，刀叉等餐具。
- ◆ 器具在使用期间会发热，注意避免接触器具内的发热单元，以免烫伤和灼伤。
- ◆ 器具只适用于家庭烹饪，不能作烹饪食物以外的用途，例如用于烘干物品等，有可能引起火灾。
- ◆ 器具不能用于实验室实验或其他商用用途。
- ◆ 如发现有烟雾，或器具内着火，切勿打开器具门，应取消烹饪模式，关掉器具开关或拔掉电源插头，并保持器具门关闭，以抑制火焰蔓延。
- ◆ 切勿使用微波模式加热化学试剂或其他非食品制品，以免引起微波外泄。
- ◆ 如果电源软线损坏，为了避免危险，必须由制造商、其维修部或类似部门的专业人员更换。
- ◆ 单独使用10A或以上的插座，请勿与几个电器同时使用同一个电源插座，并确保插座安全有效接地。
- ◆ 若器具出现故障请立即断开电源停止使用，并且不要触摸器具，请专业人员维修。
- ◆ 不得损伤电源线。使用电源线时不得弯曲、拉伸、扭转、打结。不得用重物扣压、夹击电源线。
- ◆ 为防止火警，器具必须保持清洁，风道必须畅通无阻。
- ◆ 警告：不要使用粗糙清洗剂或锋利的金属刮刀清洁器具门的玻璃，如果器具门的玻璃表面会擦伤，这样做会导致玻璃粉碎。
- ◆ 不可将易燃物质（例如烟雾剂）放置在器具的里面和下面；使用器具时，不得在其附近喷洒烟雾剂，必须始终有人看管。
- ◆ 器具长期不使用，应切断电源。
- ◆ 请勿在手脚潮湿或赤脚的状态下操作器具。
- ◆ 用好后立即关闭器具，否则残余的脂肪会引发火警。
- ◆ 清洗时必须切断电源，注意使用中性和清洗剂。同时使用柔软抹布擦洗，防止划伤表面。
- ◆ 使用微波模式时，奶瓶和婴儿食品罐应经过搅拌或摇动，喂食前应检查瓶内食物温度，避免烫伤。
- ◆ 使用完毕后，请勿直接清洗器具，务必在其冷却后再进行清洗，以免发生烫伤。
- ◆ 使用微波模式时，食物必须放入合适微波模式的安全器皿中，不能直接在底板玻璃上烹饪食物。
- ◆ 非专业人员不得擅自安装、拆机修理或更换零件。

- ◆警告：除有资格的维修人员外，其他人来执行检修操作都是危险的，包括拆下防止微波能量泄漏的防护盖等操作。
- ◆使用微波模式烹饪爆米花必须用器具专用爆米花容器。一些纸袋包装的可以直接烹饪，烹饪时切勿离开。
- ◆使用微波模式加热土豆、苹果、红肠、鸡翅等带皮的食物在烹饪前必须用刀叉穿孔以防止破裂或爆炸。
- ◆在微波模式下，器具不能用来加热带壳的鲜蛋和已煮熟的蛋，因为在微波加热时甚至在加热之后他们可能会爆炸。
- ◆器具加热饮料会导致延时喷溅沸腾，因此取出时必须小心谨慎。
- ◆使用微波模式加热塑料或者纸包装的食物时，应注意观察器具，因为有着火的可能，例如快餐食品。
- ◆警告：不能直接用微波模式加热装在密封容器内的液体或其他食物，因为这样可能发生爆炸。例如罐头食品，密闭玻璃瓶。
- ◆使用微波模式时，不要过度烹饪食物。
- ◆警告：禁止无人照看的幼儿和残疾人使用此器具，并禁止儿童玩耍器具。
- ◆警告：在使用时可触及部分可能会发热。儿童应远离。
- ◆勿让儿童等不熟悉器具操作的人员操作。
- ◆当器具以组合模式工作，因温度升高，儿童必须在成人的监督下使用。
- ◆不清洁器具会致使器具表面劣化，这会影响器具的寿命可能导致危险的情况。
- ◆若器具出现功能不正常时，请拔掉电源插头重新上电。
- ◆使用时内部脆烤盘等放置必须正确到位。
- ◆器具不能用作室内取暖器。
- ◆不能使用蒸汽清洁器。
- ◆警告：运行微波模式时禁止将脆烤盘放入底板玻璃上使用。

## 产品简介

### 亲爱的用户：

让我们借此机会，对于您购买了老板牌微烤一体机表示衷心的感谢。我们特别建议您在着手安装和使用本产品前，有必要仔细阅读此说明书，并请将其妥善保存，以备今后查阅。

本公司是国内生产吸油烟机、微烤一体机、燃气灶具、消毒柜、电烤箱等家用电器和厨具的专业企业；老板牌微烤一体机采用先进的设计理念，注重整体设计、优化造型；它具有健康、环保、节能等优点。

使用独有的电码防伪标志，保证用户购买正牌产品，维护自身利益。

本产品属于I类器具，使用时必须具有可靠的接地。

※本说明书中的产品图片仅供参考，产品以实物为准。本公司产品持续改进，因产品改进所引起的内容变更，恕不另行通知。

### 重要信息

#### 微烤一体机的包装

请以环保的态度处置这些包装材料，以保持一个良好的环境。

请勿让儿童玩耍塑料薄膜、纸箱等包装材料，这可能会产生窒息事故，所以请让包装材料远离儿童。

### 产品结构

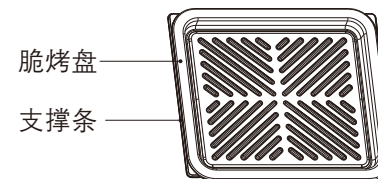
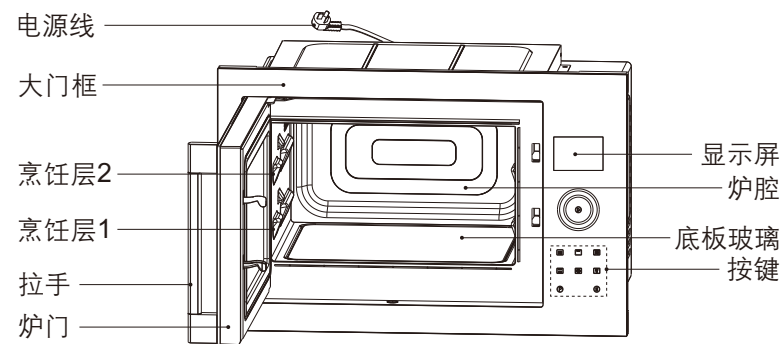

产品技术参数



型号	WKQS-26-CQ935H01
额定电压	220-240V~
额定频率	50-60Hz
额定输入功率	1560W
烤烧输入功率	870W
微波输出功率	1000W
微波额定频率	2450MHz
总容积	28L
有效容积	26L
噪音	65dB(A)声功率级
净重	17kg
外形尺寸(mm) 宽×高×深	595×385×388







附件清单

序号	名称	数量
1	说明书	1份
2	脆烤盘	1个
3	安装说明	1份
4	定位片	1个
5	ST4.2×12自攻螺钉	3个
6	ST3.5×30自攻螺钉	1个



烹调用具选择

不同的烹饪方式,选择适当的烹饪容器十分必要,请参照下表使用。

容器种类	微波模式	烤模式	组合模式
耐热性玻璃容器 	可以使用	可以使用	可以使用
不耐热性玻璃容器 	不能使用	不能使用	不能使用

容器种类	微波模式	烤模式	组合模式
耐热性塑料容器 	可以使用 注:*使用"微波炉专用"标识的器具。 *密封容器禁止使用。	不能使用	不能使用
不耐热性塑料容器 	不能使用	不能使用	不能使用
陶瓷容器 	可以使用 注:具有金属装饰件的禁止使用。	可以使用	可以使用 注:具有金属装饰件的禁止使用。
金属容器 	不能使用	可以使用	不能使用
木、竹、布材质容器 	不能使用	不能使用	不能使用
铝箔纸、锡箔纸等 	不能使用	可以使用	不能使用
食物保鲜膜 	可以使用	不能使用	不能使用
脆烤盘 	不宜使用	可以使用	可以使用

注:● 在使用微波模式时,建议使用广口的微波炉专用的玻璃容器或者陶瓷容器。

例如:   禁止使用缩口容器。例如: 

- 脆烤盘取放时勿在门体上拖动,以免损坏门体玻璃。
- 脆烤盘放到烹饪层上使用。
- 使用后脆烤盘及整个炉腔内壁及顶部都很烫,切勿用手接触,以免烫伤。
- 经常清洁此脆烤盘。
- 烹调食物时,把食物放在脆烤盘中间波浪状区域。避免因食物进入四周的凹槽而不能完全烤熟。
- 脆烤盘可用于烤烧、组合以及双驱烤烹饪模式。

安装说明

在橱柜的设定位置上,按下面安装图示设定方孔,将微烤一体机平稳嵌入该方孔,注意不得倾斜安置,具体开孔尺寸(mm)见下表:

序号	名称	W	H	D
1	全嵌开孔尺寸(宽×高×深)	600	395	450
2	半嵌开孔尺寸(宽×高×深)	560	380	450



**安装方法:**

A、把安装说明平铺在橱柜底，安装说明中心与橱柜中心对齐。安装说明前部边缘与橱柜前边缘对齐。依照安装说明上螺丝的位置，在橱柜上做标记。把定位片按正确方向放置在标记处，用三个螺钉(4.2×12)固定在橱柜。如图4所示。(定位片凸出边朝向橱柜前方)

B、将机器放入橱柜，使外框与橱柜左右距离相同。将机器向后推到位，使定位片卡在产品定位槽内。打开机器门，在内胆前上部的螺钉位置，用螺钉(3.5×30)将产品固定在橱柜上。

C、全嵌安装时，橱柜在制作时，应按照图3所示，在橱柜顶部安装固定木板。

D、插座位置应插接方便，并且可靠接地。



图3: 全嵌安装固定木板示意图



图4: 安装示意图

不要接近电视机、收音机和天线等。(否则会干扰图像和产生噪音)

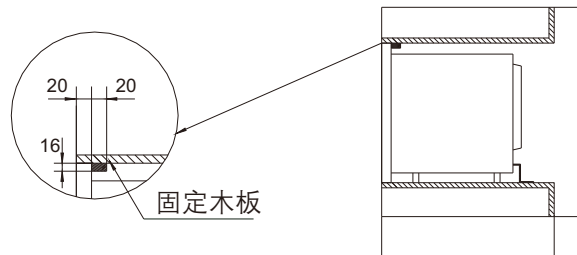
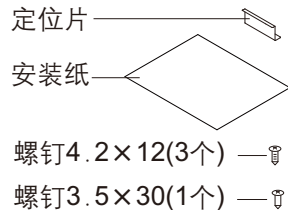
不可将微烤一体机放置于高温潮湿的地方。例如煤气炉，带电区域或水槽旁。

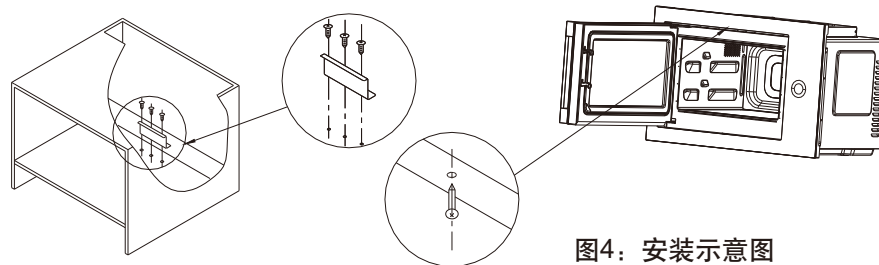
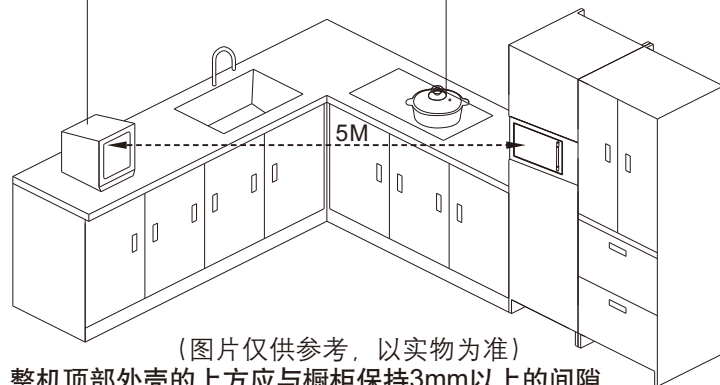

(图片仅供参考，以实物为准)

注：整机顶部外壳的上方应与橱柜保持3mm以上的间隙。

电源：老板微烤一体机应单独使用供电系统。如不用这个系统，可能会熔断保险丝或延长烹调时间。电路中不可使用大容量保险丝。

接地说明：本设备必须接地。插头必须接插在确实接地的插座上。电源线接插必须方便，确保微烤一体机安装后可随时断开电源。

注意：如果室内温度过高则不能使用本微烤一体机。本微烤一体机只适用于家庭。

注：图中尺寸单位均为mm。



图1: 整机尺寸示意图

图2: 开孔尺寸示意图

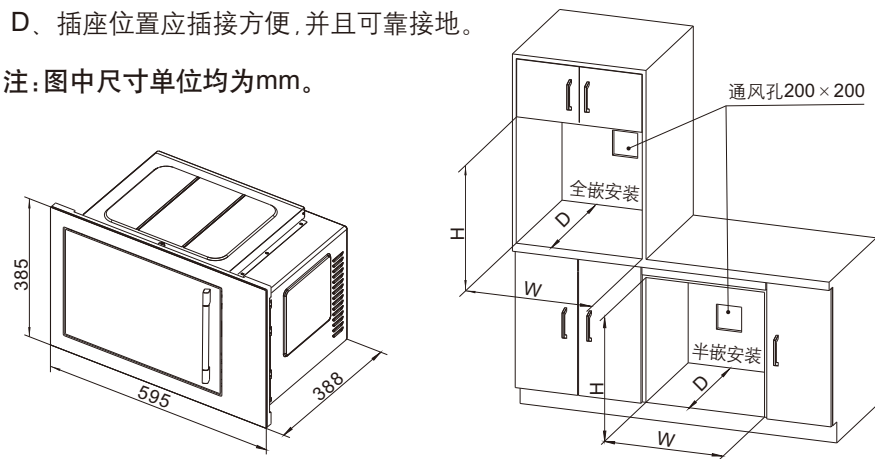
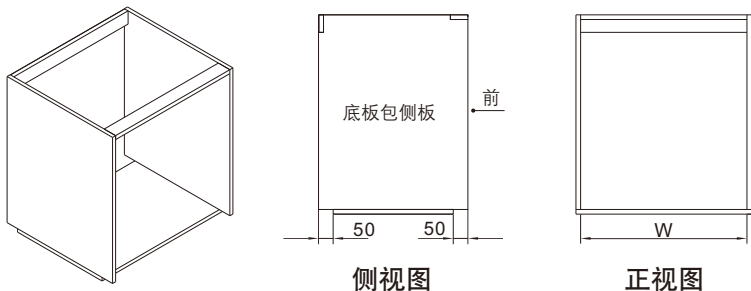

注：当产品安装位置为地柜时，为确保产品门体与左右柜门形成整体一致的视觉效果，建议采用上图所示的地柜结构图。

## 使用方法

### 控制面板介绍

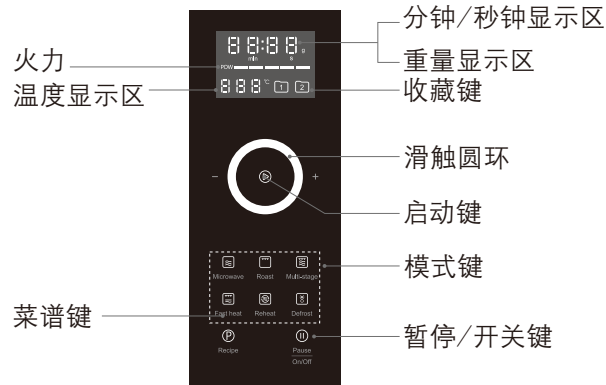

### 使用前说明

- 新产品首次使用时，因为加热元件的保护涂层挥发会产生异味，所以在保证产品周边环境通风良好的情况下，选择烤烧模式，设定180°C，空腔运行60分钟，从而去除保护涂层。工作结束待机器冷却后，使用湿润的抹布对内胆进行擦拭清洁。后续烹饪即可正常进行，产品无异味。

### 使用方法

#### 1. 通电

接通电源，发出提示音，屏幕显示与按键全亮，数秒后“- -”闪烁，其余灯灭，进入待机状态(如下图)，待机状态下短按任意按键或触摸屏区域进入等待开机状态，“- -”和暂停/开关键闪烁(如下图)。



注：等待开机状态下，若数分钟内无任何操作，返回待机状态。

#### 2. 开机

长按“⏻”键开机，进入默认模式(如下图)。

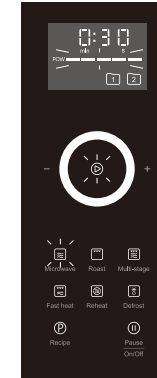

#### 3. 选择烹饪模式

用户可根据自己的需求，选择微波“☰”、烤烧“☷”、组合“☶”、双驱烤“☸”、复热“☹”、解冻“☺”六个烹饪模式。

#### 微波、组合模式

- ①在模式选择状态下，短按模式键选择所需的模式，屏幕显示火力文字及时间、单位、收藏图标，默认被选模式键、启动键及火力条闪烁；
- ②如需调节烹饪火力，短按火力条，火力条闪烁，可连续点击火力条调节火力、可连续按闪烁的模式键调节火力、可短按滑触圆环增加/减小火力；
- ③如需调节烹饪时间，短按分钟显示区域，分钟显示区域闪烁，短按滑触圆环调节分钟；短按秒钟显示区域，秒钟显示区域闪烁，短按滑触圆环调节秒钟；
- ④设置完成后，按“▶”键启动，自动进入工作模式，工作完成时，蜂鸣器鸣叫提示。

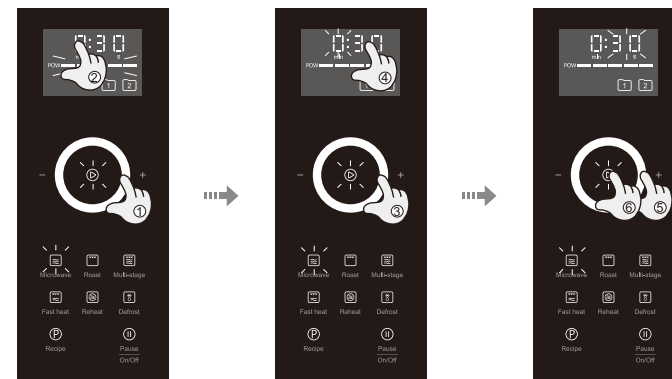

### 烤烧模式

- ①在模式选择状态下，短按烤烧键选择烤烧模式，屏幕显示时间、温度及单位、收藏图标，默认烤烧键、启动键及温度显示区闪烁；
- ②如需调节烹饪温度（温度分3档140℃、160℃、180℃），短按温度显示区，温度显示区闪烁，可连续点击温度显示区调节温度、可连续按闪烁的烤烧键调节温度、可短按滑触圆环调节温度；
- ③如需调节烹饪时间，短按分钟显示区域，分钟显示区域闪烁，短按滑触圆环调节分钟；短按秒钟显示区域，秒钟显示区域闪烁，短按滑触圆环调节秒钟；
- ④设置完成后，按“▶”键启动进入预热状态，预热结束蜂鸣器鸣叫提示并自动进入工作模式，工作完成时，蜂鸣器鸣叫提示。

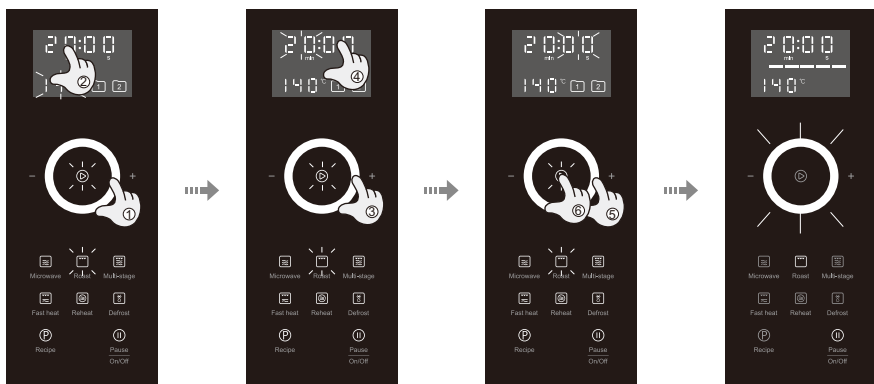

### 双驱烤模式

- ①在模式选择状态下，短按双驱烤键选择双驱烤模式，屏幕显示火力文字、火力条及时间单位、收藏图标，默认双驱烤键、启动键及时间显示区闪烁；
- ②如需调节烹饪时间，短按分钟显示区域，分钟显示区域闪烁，短按滑触圆环调节分钟；短按秒钟显示区域，秒钟显示区域闪烁，短按滑触圆环调节秒钟；
- ③烹饪火力默认5档，不可调节；
- ④设置完成后，按“▶”键启动，自动进入工作模式，工作完成时，蜂鸣器鸣叫提示。

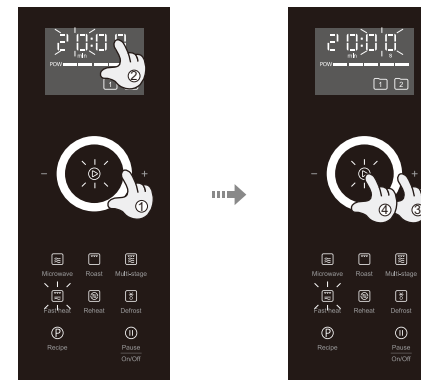

### 复热、解冻模式

- ①在模式选择状态下，短按模式键选择所需的模式，屏幕显示火力文字、火力条、重量及单位，默认被选模式键、启动键及重量显示区闪烁；
- ②如需调节重量，短按滑触圆环进行调节，短按一次调节100g（复热模式重量调节范围为200g-600g，解冻模式重量调节范围100g-3000g）；
- ③烹饪火力复热模式默认5档，解冻模式默认2档，不可调节；
- ④设置完成后，按“▶”键启动，自动进入工作模式，工作完成时，蜂鸣器鸣叫提示。

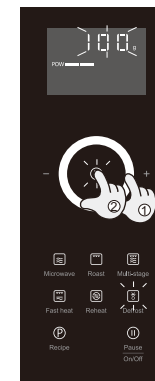

注：●如无需调节烹饪火力、时间、温度、重量，模式选择完毕后，可直接按“▶”键启动。

- 设定火力、时间、温度、重量，用户可根据烹饪参考表，也可根据个人口感及烹饪经验调整。
- 长按圆环两端或滑动滑触圆环可连续递增/递减参数。
- 部分模式具有烹饪记忆功能，在未断电的状态下，再次开机可记忆上次工作的烹饪模式。

■菜谱功能

1. 按“P”键进入菜谱设置，屏幕显示时间参数及单位，菜谱序号、菜谱键及启动键闪烁；
2. 短按菜谱序号或滑触圆环选择所需菜谱，其对应的关系如下表；
3. 选择完成后按“D”键进入工作状态。

注：●若需要调节时间参数，短按分钟/秒钟显示区域，分钟/秒钟显示区域闪烁，短按滑触圆环调节时间，调节完成后按“D”键进入工作状态。  
●再次短按“P”键则退出菜谱功能。

菜谱序号对应表格

序号	菜谱名称	烹饪层位置	是否需要预热
P01	杂粮饭	底板层	/
P02	皮蛋瘦肉粥	底板层	/
P03	脆底面包	1	/
P04	蜀香烤鱼	2	/
P05	培根蔬菜卷	2	是
P06	什锦烤串	2	/
P07	烤牛排	1	/
P08	烤披萨	2	/
P09	鸡蛋三明治	1	/
P10	爆米花	底板层	/
P11	奥尔良鸡翅	2	/
P12	酥嫩大鸡排	2	是
P13	烤生蚝	2	是
P14	迷迭香烤羊排	2	/
P15	虾仁豆腐	底板层	/
P16	蒜香大虾	底板层	/

注：●部分菜谱需要中途将食物取出加工，机器会鸣叫提醒用户。

■收藏设置

1. 可将常用的模式、参数放至收藏夹以备下次使用。具体操作如下：如收藏“微波”功能，则先在开机状态下设置好微波功能的火力和时间参数，长按“1”或“2”键，蜂鸣器鸣叫提示，收藏完成。

2. 如需使用收藏夹内参数，在开机状态下，按“1”或“2”键，然后直接按“D”键开始烹饪。如需退出收藏夹，先按“H”键暂停工作，再按“1”或“2”键退出。

注：●仅微波、烤烧、组合、双驱烤四个模式可收藏；  
●已收藏的参数不可调节；  
●当前收藏可覆盖已收藏参数。

■调整设置

在工作过程中，若想更改设定的模式、火力、时间、温度、重量，请先按“H”键停止工作，处于可调节状态，此时可重新设置模式、火力、时间、温度、重量，调整完成后按“D”键启动工作。

注：●复热、解冻模式暂停后不可调整重量。

■照明功能

1. 工作状态下灯常亮，暂停工作或工作结束自动打开照明，数分钟后，无操作熄灭；
2. 开门或关门自动打开照明，数分钟后，无操作熄灭。

■关机

1. 在开机状态下长按“H”键，进入待机状态。
2. 在非工作状态下，数分钟后无任何操作自动进入待机状态。
3. 工作结束后，进入待机状态。

工作模式

功能	默认火力	默认温度	默认重量	默认时间
微波	POW	/	/	30s
烤烧	/	3档: 180°C	/	20min
组合	POW	/	/	20min
双驱烤	POW	/	/	20min
复热	POW	/	200g	/
解冻	POW	/	100g	/

功能	火力范围	温度范围	重量范围	时间范围
微波	POW	/	/	5s-90min
	POW			
	POW			
	POW			
	POW			5s-30min
烤烧	/	1档: 140°C 2档: 160°C 3档: 180°C	/	1-90min
组合	POW	/	/	1-90min
	POW			
	POW			
	POW			
	POW			
双驱烤	POW	/	/	1-90min
复热	POW	/	200g-600g	/
解冻	POW	/	100g-3000g	/

烹饪参考表

模式	食物	烹饪层位置	使用器具	温度 (°C) / 档位	设置时间 (min)
微波	大虾	底板层	/	5档	4-10
	蔬菜 (菠菜)	底板层	/	4档	4-10
	豆腐	底板层	/	5档	5-10
	三明治	1	/	3档	2-10
	爆米花	底板层	/	5档	2-6
烤烧	培根蔬菜卷	2	脆烤盘	180	8-25
	生蚝	2	脆烤盘	180	5-25
	鸡排	2	脆烤盘	180	10-30
	面包片	1	脆烤盘	180	5-15
	蛋糕卷	1	脆烤盘	140	20-35
双驱烤	蔓越莓饼干	1	脆烤盘	160	10-25
	脆底面包	1	脆烤盘	/	10-25
	披萨	2	脆烤盘	/	15-30
组合	烤鱼	2	脆烤盘	5档	15-40
	烤串	2	脆烤盘	5档	18-30
	牛排	1	脆烤盘	4档	5-20
	羊排	2	脆烤盘	5档	15-35
	鸡翅	1	脆烤盘	5档	15-30
	琵琶腿	2	脆烤盘	5档	15-40

模式	食物	备注
微波	大虾	冷冻对虾约重300g
	蔬菜 (菠菜)	菠菜切两段, 约重400g
	豆腐	内酯豆腐约重300g, 切片
	三明治	吐司4片
	爆米花	微波专用爆米花约重100g
烤烧	培根蔬菜卷	培根约重250g, 蔬菜约重200g
	生蚝	生蚝约重800g
	鸡排	鸡胸约重150g
	面包片	吐司9片, 去边
	蛋糕卷	整盘1盘, 鸡蛋6个
双驱烤	蔓越莓饼干	整盘1盘
	脆底面包	约重50g/个, 共8个
	披萨	速冻披萨饼底8寸

模式	食物	备注
组合	烤鱼	鲈鱼约重450g
	烤串	约重60g/串，共9串
	牛排	牛排1块，约重200g
	羊排	法式羊排约重600g，共6块
	鸡翅	鸡翅中12个
	琵琶腿	琵琶腿2个

- 注：●以上表格中食物烹饪温度、时间只做参考，食物在烹饪过程中，用户可根据个人口感及烹饪经验调节烹饪温度、时间、模式、烹饪层。
- 在烤烧模式下，烘烤鸡、鸭及较大肉类时建议最好先以低温烘烤，然后转换成高温烘烤使口感更佳。
  - 在烤烧模式下，烘烤食物前，需腌制的食物用户可用调制好的配料腌制约30分钟-40分钟，这样可使食物更入味。
  - 用户也可根据个人烹饪经验对同一食物选用不同模式进行烹饪。
  - 在烤烧模式下，烘烤过程中为受热均匀，建议对食物进行翻面。
  - 实际烹饪过程中，受器具种类、食物重量等影响应适当调整烹饪时间。
  - 在解冻模式下，因食材大小、形状及种类不同，解冻效果不同，解冻重量数据仅供参考，用户可以根据实际情况调节重量数据增加/减少解冻时间。

### 烘烤时常见现象及处理

现象	原因分析	处理
烘烤不均匀	*烤层位置不正确 *食物没有放在脆烤盘居中位置 *功能选择不正确	*选择适合的烤层位置 *把食物放在脆烤盘居中位置 *选择正确的功能
烤出的食物上层颜色或底部颜色较深	*功能选择不正确 *食物大小不一或食物未放均匀 *烘烤温度太高 *烤层位置太高或太低 *烘烤期间微烤一体机门开的次数太多	*选择正确的功能 *食物大小切均匀，并在脆烤盘上放均匀 *调低温度 *改放到低一层或高一层的位置 *至少烤到一半时间才可以开一次微烤一体机门
烤出的糕饼有裂缝和深厚的锅巴层	*时间太长 *烘烤温度太高 *烤层位置太高 *制作糕饼配方或操作过程有误 *容器选择不正确	*调整时间 *调低温度 *放低一层位置 *调整配方，正确操作流程 *更换适合的容器
烤出的食物颜色浅及未烤透	*烘烤温度太低 *烤层位置太低 *烘烤时间太短	*调高温度 *放高一层 *延长烘烤时间

## 维护和保养

**重要提示：清洗微烤一体机前，必须先切断电源。**

必须始终保持器具的清洁，确保发热元件、内腔没有积聚脂肪和油渍；脆烤盘等必须清洗干净，以免脂肪积层引发火警；肉食在烘烤时可用铝箔纸包裹，以便清洁；任何脂肪和油渍都会在器具内结成一层漆状积层，难以清洗，所以在每次使用后应清洁干净。

1. 内腔：用温水清洗，不要使用具有腐蚀性和具有研磨性的清洁剂清洗。难去除的污渍可用尼龙刷或中性清洁剂清洗，不可用钢丝球擦洗，以免造成表面不可修复的损伤。腔内的清洁剂必须清洗干净不能有残留，清洗后用抹布擦干，保持腔内干燥。

2. 大门框玻璃、底板玻璃：门和控制板、底板上的玻璃面一受脏就要立即清洁，牢固的污垢可用中性清洁剂清洗，不可用钢丝球擦洗，以免划伤表面，清洗后用抹布擦干。

3. 门封条：不可拆卸，使用后用抹布擦拭，不要使用具有腐蚀性和具有研磨性的清洁剂清洗，难去除的污渍可用尼龙刷或中性清洁剂清洗，不可用钢丝球擦洗，以免造成表面不可修复的损伤。

4. 在微烤一体机正常运转或湿度高的情况下，一体机门周围或一体机内都有可能产生水蒸汽，可用软布擦净。

5. 如控制面板被弄湿，请用软性干布抹擦，不可用粗糙、磨损性的物品擦控制面板。

6. 请用软性湿布清洗微烤一体机表面，为防止损坏微烤一体机内部件，不要让水渗入通风口。

## 常见故障及处理方法

下表所列为一般故障，请按所列指示进行确认和处理，如仍处理不了或不能确认故障原因时，请与当地经销商或售后服务中心联系。为了您的安全着想，我们特别提醒，请勿自行拆卸修理。

故障现象	原因	处理方法
显示屏显示E3	加热故障 开始工作8分钟内温度变化小于5°C且没有达到设定温度的80%	进入待机状态后可自动取消，再次工作还是故障，建议断电后，检查接插件是否松脱或加热管是否异常，排除故障，再开机，若不能排除，请联系专业人员维修处理
显示屏显示E5	温度传感器故障 短路或开路	建议断电后，检查接插件是否松脱或温度传感器是否损坏，排除故障，再开机，若不能排除，请联系专业人员维修处理
显示屏显示E6	通讯故障 面板和电源板通讯异常	建议断电后，检查通信线或程序是否匹配，排除故障，再开机，若不能排除，请联系专业人员维修处理
显示屏显示ERR	变频器故障 微波通信异常或微波不工作或工作异常	建议断电后，检查接插件是否松脱或变频器是否异常，排除故障，再开机，若不能排除，请联系专业人员维修处理
显示屏显示/	防污渍 面板和电源板通讯异常	擦除污渍即可

## 电气原理图

